

A10213-3 1300Kgs/ 3000Lbs
A10213-5 2300Kgs/ 5000Lbs
 E Spring Hook

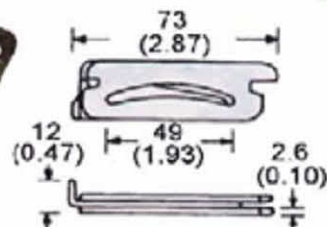

A10214
 2" Series E,A, 3-Pieces Fitting .
 B/S: 1,360Kgs/ 3,000Lbs

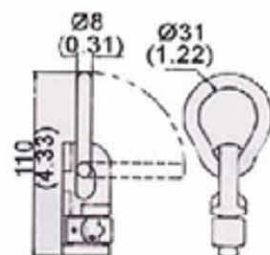

A10216P
 Double Stud Fitting With Pear Ring
 B/S: 2,500Kgs/ 5,000Lbs

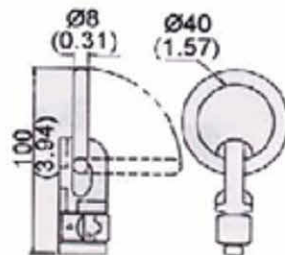

A10216R
 Double Stud Fitting With O- Ring
 B/S: 2,500Kgs/ 5,000Lbs

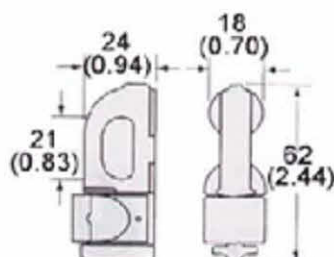

A10216
 Double Stud Fitting
 B/S: 2,300Kgs/ 5,000Lbs



A10219
 Combi Double Stud Assy
 B/S: 2,300Kgs/ 5,000Lbs

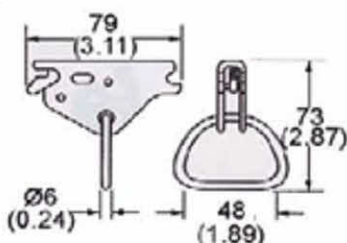

A10217D
 2" Series E/A Fitting With 2" D-Ring .
 B/S: 1,850Kgs/ 4,000Lbs

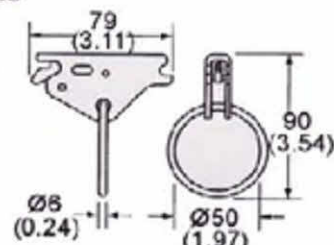

A10217R
 2" Series E/A Fitting With 2" O-Ring .
 B/S: 1,850Kgs/ 4,000Lbs

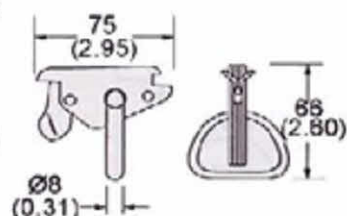

A10218D
 2" Series E/A Fitting With 2" D-Ring .
 B/S: 2,500Kgs/ 5,000Lbs

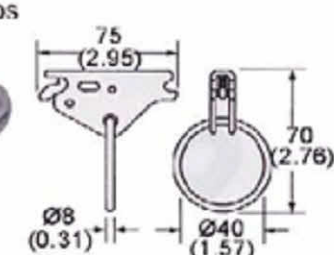

A10218R
 2" Series E/A Fitting With 2" O-Ring .
 B/S: 2,500Kgs / 5,000Lbs

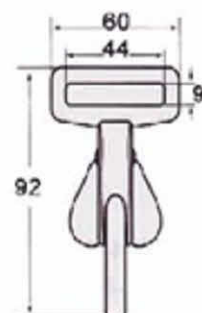

FH111
 Parachute Snap Hook
 1-3/4"/45mm
 Forged Steel, Zinc Plated
 B/S: 2300Kgs/ 5000Lbs

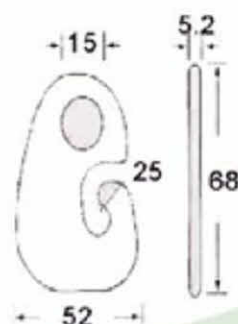

FH117
 Forged Body Hook
 B/S: 1300Kgs/ 3000Lbs

Chain Anchor & Accessories

RB

Chain Anchor

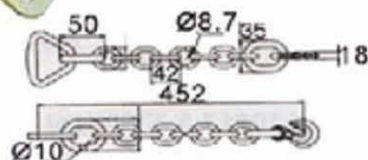
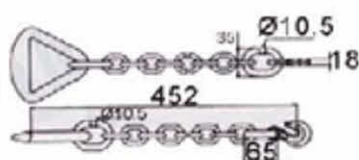

FH87-1

Chain Anchor, 18" Long
B/S: 7350kgs/16200lbs

FH87-2

Chain Anchor, 18" Long
B/S: 4540kgs/10000lbs

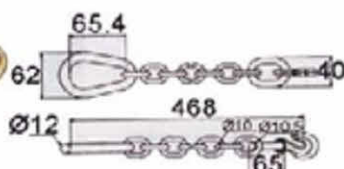

FH89

Chain Anchor, 18" Long
B/S: 7350kgs/16200lbs

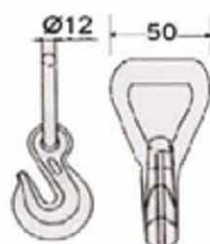

FH88C

Triangle And Hook With Safety Latch, Galvanized
B/S: 5000kgs/10000lbs

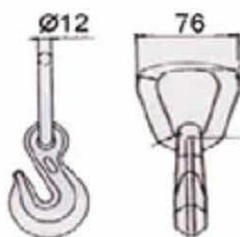

FH88

Triangle Hook With Safety Latch
B/S: 5000kgs/10000lbs

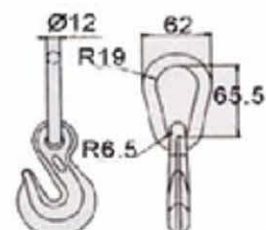

FH90

Grab Hook
B/S: 7350kgs/16200lbs

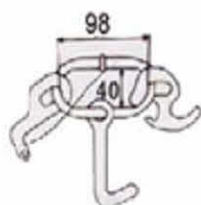

FH-RTJ

Cluster Hook
B/S: 6,000kgs/12,000Lbs

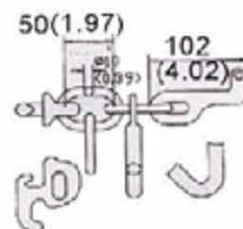

FH-RTJ-O

W/O Ring
Cluster Hook
B/S: 6000kgs/12000lbs

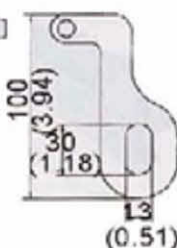
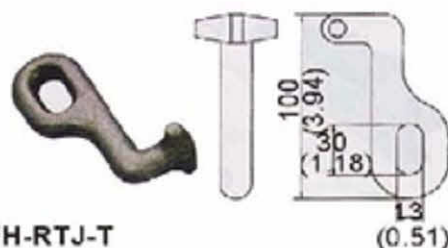

FH-RTJ-T

T Hook
B/S: 6,000kgs/12,000lbs

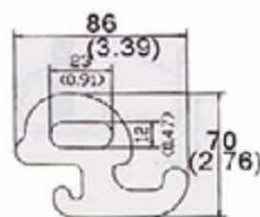

FH-RTJ-R

R Hook
B/S: 6,000kgs/12,000lbs

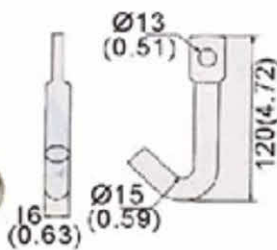

FH-RTJ-J

J Hook
B/S: 5,000kgs/11,000lbs

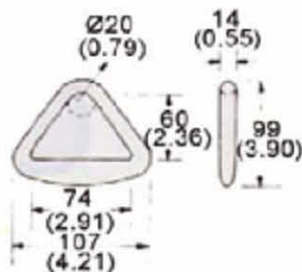

FH94-3

3" D-Ring
B/S: 8,000kgs/18,000lbs

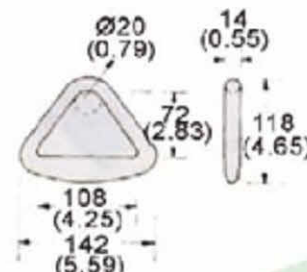

FH94-4

4" D-Ring
B/S: 10,000kgs/22,000lbs

Chain & Tow Chain

RB



Safety Chain For Trailer

TC02-316
3/16" Chain x3/8" Hooks x2,000Lbs Max.Load

TC02-14
1/4" Chain x7/16" Hooks x3,500Lbs Max.Load

TC02-516
5/16" Chain x17/32" Hooks x5,000Lbs Max.Load
Length:36",48",60",70", please specify when ordering.

G30 PROOF COIL CHAIN NACM90		
ITEM	CHAIN SIZE	W.L.L. IN LBS
G30-18	1/8"	375
G30-316	3/16"	750
G30-14	1/4"	1,250
G30-516	5/16"	1,900
G30-38	3/8"	2,600
G30-716	7/16"	3,500
G30-12	1/2"	4,500
G30-58	5/8"	6,900
G30-34	3/4"	9,750
G30-78	7/8"	11,575
G30-1	1"	13,950

G43 HIGH TEST CHAIN		
ITEM	CHAIN SIZE	W.L.L. IN LBS
G43-14	1/4"	2,600
G43-516	5/16"	3,900
G43-38	3/8"	5,400
G43-716	7/16"	7,200
G43-12	1/2"	9,200
G43-58	5/8"	11,500
G43-34	3/4"	16,200

G70 TRANSPORT CHAIN By 10',15',20'		
ITEM	SIZE	W.L.L. IN LBS
G70-14	1/4"	3,150
G70-516	5/16"	4,700
G70-38	3/8"	6,600
G70-12	1/2"	11,300

G80 ALLOY CHAIN		
ITEM	CHAIN SIZE	W.L.L. IN LBS
G80-932	9/32"	3,500
G80-38	3/8"	7,100
G80-12	1/2"	12,000
G80-58	5/8"	18,100
G80-34	3/4"	28,300

CHAIN IN STAINLESS STEEL #304/#316		
ITEM	CHAIN SIZE	W.L.L. IN LBS
SS-18	1/8"	400
SS-316	3/16"	750
SS-14	1/4"	1,250
SS-516	5/16"	1,900
SS-38	3/8"	2,650
SS-12	1/2"	4,500

V Chain Assembly W/J Hook *Not For Recovery!*

G70 Chain + Hooks, W/2' Legs

TC711J-152-G7 G70 5/16" Chain & Component At 4,700Lbs WLL, W/2' Legs & 15" J Hook.

TC711J-82-G7 G70 5/16" Chain & Component At 4,700Lbs WLL, W/2' Legs & 8" J Hook.

TC711J-153-G7 G70 5/16" Chain & Component At 4,700Lbs WLL, W/3' Legs & 15" J Hook.

TC711J-83-G7 G70 5/16" Chain & Component At 4,700Lbs WLL, W/3' Legs & 8" J Hook

V Chain Assembly W/Cluster Hooks

TC712C-2-G7 G70 5/16" Chain & Component At 4,700Lbs WLL, W/2' Legs & Cluster Hook.

TC712C-3-G7 G70 5/16" Chain & Component At 4,700Lbs WLL, W/3' Legs & Cluster Hook.

#All G70 Chain + Components are in Yellow Chromed.

J T & Grab Hook Chain, 6' & 10' Long *Not For Recovery!*

Features a T & Grab hook on one end and a 8" or 15" J hook on the other end. Sold In Pairs.

TC713J-G7-86 G70 5/16" Chain & Component At 4,700Lbs WLL, W/6' Chain & 8" J Hook. Idea for use on Small Car Carrier.

TC713J-G7-810 G70 5/16" Chain & Component At 4,700Lbs WLL, W/10' Chain & 8" J Hook. Idea for use on Large Car Carrier.

Pear Link W/2 Grab Hooks

TC707-G7 G70 5/16" Component, 4,700Lbs WLL.

J Hook

TC-709-15-G7 15" Long J Hook, 7/8" Eye for use on G70 X 5/16" Chain, 4,700Lbs WLL.

TC-709-8-G7 8" Long J Hook, 7/8" Eye for use on G70 5/16" Chain, 4,700Lbs WLL.

G40 Chain + Hooks are available with 3,900Lbs WLL In Loading, but in Brite Galvanized.

Coil Rack

Light Duty 10 Gauge Steel, Weight: 5.7 lbs



A1193-2



A1193-4

A1193-2 2" A1193-4 4"
Corner Protector
For Webbing & Chain



Transport Chain G70



TC711J-152

TC709



TC712C-2'

TC707

Chain package



Pail



Drum



Floor Mounting Ring

RB



RH01-5M
Recessed Floor Ring
2300Kgs/5000Lbs, Zinc Plated

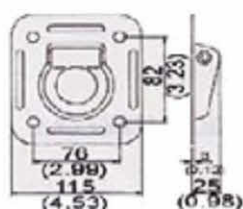

RH07
Recessed Floor Ring, 3-1/2" X 5"
Ellipse Shape, 409Kgs/900Lbs, Bright, Zinc Plated

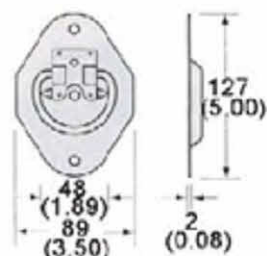

RH04-5M
Recessed Floor Ring, 2000kgs
Zinc Plated

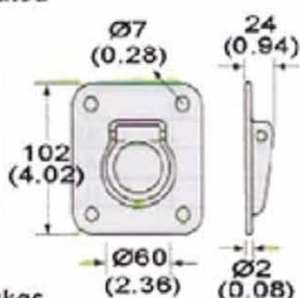

RH17-6M 6-3/8 in Diameter
Rotated D-Ring, 6000lbs

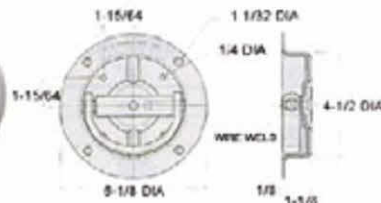

RH02S-1M Small 350kgs
RH02L-1.5M Large 2200kgs
Recessed Floor Ring

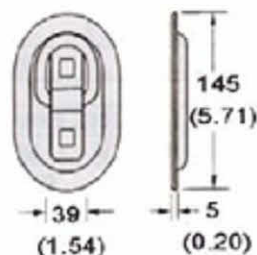

RH03-15M
D-Ring B/S: 1500kgs

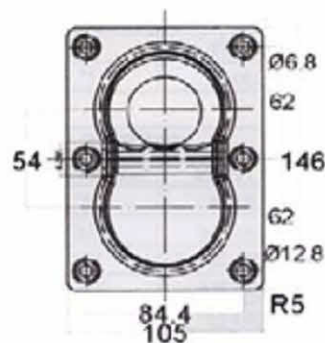

RH21
Rope Stopper
1500Kgs/3000Lbs, Chrome Plated



RH12
Surface D-Ring
B/S: 550kgs/1,200lbs



RH14
Recessed D-Ring
B/S 5000lbs



RH15
Recessed D-Ring w/pin
B/S 5000lbs

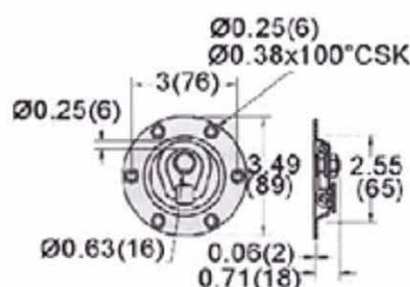

RH18
Recessed D-Ring
B/S: 500kgs

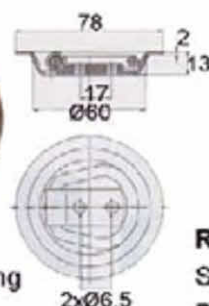

RH19
Surface Mount Ring
B/S: 500kgs

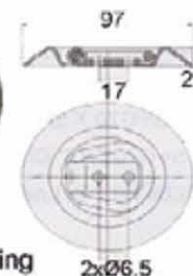

RH20-8
Surface Mount Ring
B/S: 800kgs

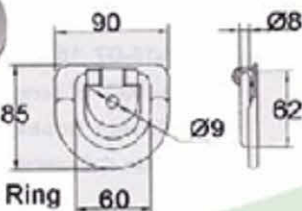

D-Ring For Towing

RB

D-Ring Washer



RH01-W



RH17-W



RH04-W Europe

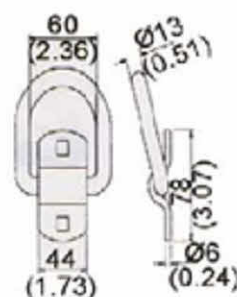

RH09-15

1" Flush Ring With Top Cap

RH10-635

35mm x 600kgs, Zinc Plated

B/S: 545kgs/1,200lbs

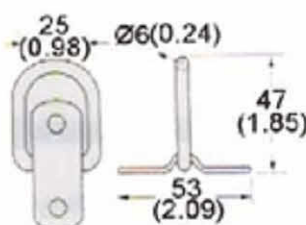

RH10

Recessed Anchor

B/S: 550kgs/1,200lbs

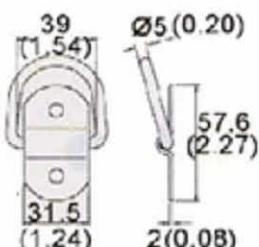

RH08-11M

W: 3 3/8" X H: 4 3/4"

Heavy Duty Recessed D-Ring
Brite Zinc Plate

B/S: 5,000kgs/12,000lbs

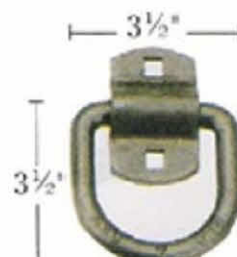

D-Ring, With Cap, Heavy Duty



RH21-12 1/2"
12.5mm
4000Lbs WLL



RH22-58 5/8"
16mm
6000Lbs WLL



RH23-34 3/4"
19mm
8800Lbs WLL



RH24-10 1"
25mm
15000Lbs WLL



RH24L-10 1"
25mm
15000Lbs WLL



FH25B-10
Curved D-Ring W/Cap 1"
15000Lbs WLL



D-Ring With Cap

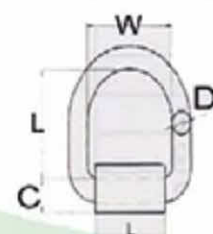

Item No.	Size		DIMENSIONS(mm)		M.B.S. (lbs)	Weight (kgs)
	D	WxL	L	C		
FH21-12	1/2"	2 1/4" x 2 1/2"	44.8	15.5	12000	0.425
FH22-58	5/8"	3" x 3"	63	23.4	18000	0.85
FH23-34	3/4"	3" x 3"	63	25.4	26500	1.225
FH24-10	1"	3" x 3"	64	30.8	47000	1.91
FH24L-10	1"	3" x 4"	64	30.8	47000	2.15



LB01



LB01C- With Safety Pin



LB02



LB02C- With Safety Pin



LB03



LB04



LB05

LB01 Load Binder, Lever Type, Fully Forged, Painted Or Power Coated			
	SIZE	SWL	BREAK LOAD (LBS)
LB01-14/ LB01C-14	1/4"-5/16"	2,200LBS	7,800LBS
LB01-5/16/ LB01C-5/16	5/16"-3/8"	5,400LBS	19,000LBS
LB01-3/8 / LB01C-3/8	3/8"-1/2"	9,200LBS	33,000LBS
LB01-1/2/ LB01C-1/2	1/2"-5/8"	13,000LBS	46,000LBS

LB02 Load Binder, Ratchet type, Partly Forged, Painted Or Powder Coated			
	SIZE	SWL	BREAK LOAD (LBS)
LB02-14/ LB02C-14	1/4"-5/16"	2,200LBS	7,800LBS
LB02-5/16/ LB02C-5/16	5/16"-3/8"	5,400LBS	19,000LBS
LB02-3/8/ LB02C-3/8	3/8"-1/2"	9,200LBS	33,000LBS
LB02-1/2/ LB02C-1/2	1/2"-5/8"	13,000LBS	46,000LBS

LB03, LB04, LB05 Load Binder, Lever Type, W/Claw Hook, Drop Forged, Painted Or Powder Coated				
	SIZE	SWL	BREAK LOAD (LBS)	
LB03-14	1/4"-5/16"	2,200LBS	7,800LBS	
LB03-5/16	5/16"-3/8"	5,400LBS	19,000LBS	
LB03-3/8	3/8"-1/2"	9,200LBS	33,000LBS	
LB04-14	1/4"-5/16"	2,200LBS	7,800LBS	(NO HOOK)
LB04-5/16	5/16"-3/8"	5,400LBS	19,000LBS	(NO HOOK)
LB04-3/8	3/8"	9,200LBS	33,000LBS	(NO HOOK)
LB05-375	MINI TYPE	375	1,300LBS	
LB05-250	MINI TYPE	250	800LBS	



MINI ERGO TYPE

HP01



HP03- 2 Hook

HEAVY DUTY TYPE



STANDARD TYPE

HP02



HP03- 3 Hook

HEAVY DUTY TYPE

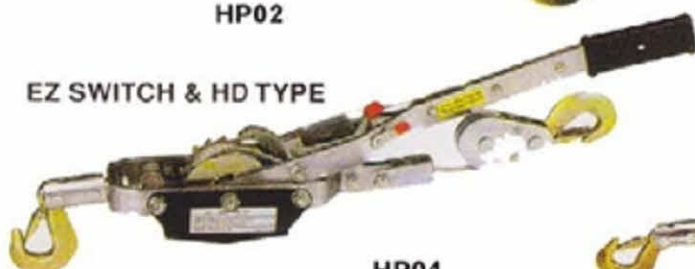

EZ SWITCH & HD TYPE

HP04



DOUBLE GEAR/SWITCH HP04

SINGLE GEAR/SWITCH

MINI ERGO TYPE

- HP01-0101 Cable Hand Power Puller, 750kgs\1,500lbs, double gear & pawl, w/2 hooks
- HP01-0102 Cable Hand Power Puller, 1,000kgs\2,000lbs, double gear & pawl w/2 hooks
- HP01-0103 Cable Hand Power Puller, 1,500kgs\3,000lbs, double gear & pawl w/2 hooks

STANDARD TYPE

- HP02-0101 Cable Hand Power Puller, 2,000kgs\4,000lbs, double gear & pawl, w/2 hooks
- HP02-0102 Cable Hand Power Puller, 3,000kgs\6,000lbs, double gear & pawl, w/2 hooks
- HP02-0103 Cable Hand Power Puller, 4,000kgs\8,000lbs, double gear & pawl, w/3 hooks

HEAVY DUTY TYPE

- HP03-0101 Cable Hand Power Puller, 2,000kgs\4,000lbs, single gear & pawl, w/2 hooks
- HP03-0102 Cable Hand Power Puller, 4,000kgs\8,000lbs, single gear & pawl, w/3 hooks

EZ SWITCH & HD TYPE

- HP04-0101 Cable Hand Power Puller, 2,000kgs\4,000lbs, double gear & pawl, w/ez switch, w/2 hooks
- HP04-0102 Cable Hand Power Puller, 4,000kgs\8,000lbs, double gear & pawl, w/ez switch, w/3 hooks



2 HOOKS

CE APPROVAL



3 HOOKS

- HP11-15 1-1/2 TON\3,000LBS, 2.6MM METAL HANDLE & BODY, SINGLE GEAR & PAWL, WITH 3 HOOKS, 3/16"X12/32MM X 3.63M GALVANIZED CABLE, COLOR BOX PACY. (MINI-135)
- HP12-20 2 TON\4,000LBS, 3.0MM METAL HANDLE & BODY, SINGLE GEAR & PAWL, WITH 2 HOOKS, 3/16"X10/32MM X 3.0M GALVANIZED CABLE, COLOR BOX PACY. (MINI-136A)
- HP13-20 2 TON\4,000LBS, 3.0MM METAL HANDLE & BODY, SINGLE GEAR & PAWL, WITH 3 HOOKS, 3/16"X10/32MM X 3.0M GALVANIZED CABLE, COLOR BOX PACY. (MINI-136B)
- HP14-40 4 TON\8,000LBS, 4.5MM METAL HANDLE & BODY, SINGLE GEAR & PAWL, WITH 2 HOOKS, 1/4"X12/32MM X 3.63M GALVANIZED CABLE, COLOR BOX PACY. (AL-131A)
- HP15-40 4 TON\8,000LBS, 4.5MM METAL HANDLE & BODY, SINGLE GEAR & PAWL, WITH 3 HOOKS, 1/4"X12/32MM X 3.63M GALVANIZED CABLE, COLOR BOX PACY. (AL-131B)

Boat Straps & Car Accessories

RB

CN03
Elastic cargo net
5mm(dia.)x36"x40"x4"
mesh + 14 hooks

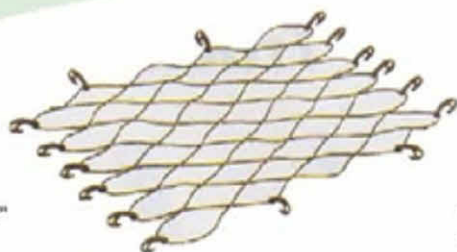

CN05
Tailgate net



CN04
Cargo net
30"x36"x12"

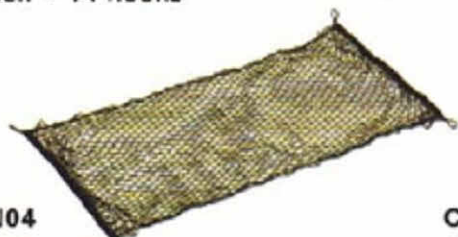

CTB01
Car top bag
37"L x12.5"W x14"H



CTB02
Car top bag
39"x32"x18" high



Rubber Straps



Boat Transom & Gunwale Straps



BT11-108 1" x 8' x 1320lbs



BT10-215 2" x 15' x 1320lbs



BT05 2" x 16' x 1320 lbs

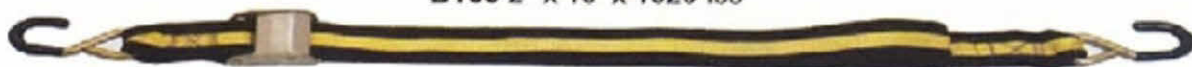

BT04 Φ 2" x 7' x 1500lbs



OT11-156 1 3/4" x 6' x 3000lbs



OT26 1" x 5 1/2' x 1200lbs

Recreational Tiedowns For Motorcycle, RV, Marine

SideCurtain Tiedown Straps

RB

Lengths 0.8m & 1.2m

OT12X-M10
W/Flat Hook
B/S: 800Kgs/1760Lbs



OT12X-W10
W/Rave Hook
B/S: 800Kgs/1760Lbs



OT19X-W10
With Rave Hook
B/S: 800Kgs/1760Lbs



OT19-M58X
With Flat Hook Stainless
B/S: 800kgs/1760lbs



OT10-08 0.8m
OT10-12 1.2m
W/Rave Hook
B/S: 800kgs/1760lbs



OT18-A205-10. 45mm
B/S: 400Kgs/880Lbs
4.5m Internal Cargo Strap
OT08-436-M205W10
45mm x 400kgs./800lbs, 3.6m



OT12-W10-1196
0.8m or 1.2m
W/Rave Hook & Screw Box
B/S: 400Kgs/880Lbs



OT18X-W10
W/Rave Hook
B/S: 1000Kgs/2200Lbs



OT21F-151
Car Lashing, 2m
B/S: 1500Kgs / 3300Lbs



OT22F-151
Car Lashing, 2m
B/S: 1500Kgs / 3300Lbs



A1196-40
Screw Box
40mm

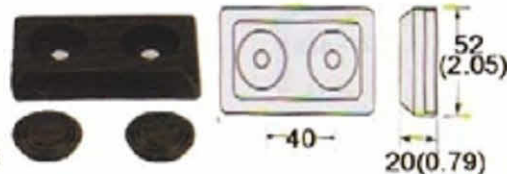

A1197-28X 28mm
A1197-40X 40mm
Plastic Back Plate
With 2PC Stainless Screws

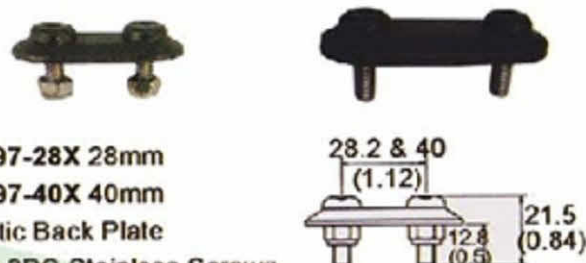

A1198-28X
Back Plate
28mm, Stainless Steel

