

產品型號目錄

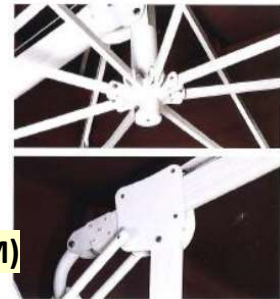

側立傘 SCD-C001(300X300CM)



側立傘 SCD-C002(Φ250CM)



產品型號目錄



SCD-C003(220X220 / 250X250CM)



常規顏色



酒紅 墨綠 米白 卡其



SCD-C004(Φ300CM)



產品型號目錄



SCD-C005(300X300CM)



常規顏色



酒紅 墨綠 米白 卡其



SCD-C006(300X300CM)



產品型號目錄



SCD-C007(Φ300CM)



SCD-C008(Φ300CM)

產品型號目錄



SCD-C008(300X300CM)



SCD-C010(300X300CM)

產品型號目錄



SCD-C011(300X300CM)



鑄鋁材質 堅固耐用



柱杆尺寸: 75x60x2.0mm
增強抗風能力



360度旋轉盤
不銹鋼螺絲 更耐用



全新ABS塑料



雙向卡手設計
減低左右搖擺



SCD-C015(Φ350CM)



常規顏色



酒紅 墨綠 米白 卡其

產品型號目錄



SCD-C016(Φ300CM / 250X250 /
300X300 / 350X350CM)



常規顏色



酒紅 墨綠 米白 卡其



SCD-C023(Φ270 / 300CM)



產品型號目錄



SCD-C019(Φ300CM)

常規顏色



酒紅 墨綠 米白 卡其 寶藍 大紅 咖啡 青綠



SCD-C021(250X250 / 300X300CM)



產品型號目錄



常規顏色

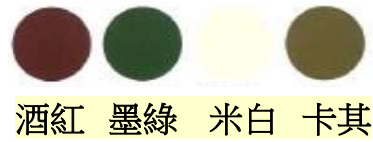

常規顏色



產品型號目錄



SCD-Z002(500X500CM)



SCD-Z003(Φ700CM)

產品型號目錄



SCD-Z004



SCD-Z010(Φ270 / 300CM)

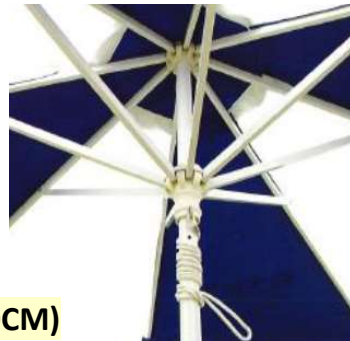

產品型號目錄



SCD-Z005(250X250 / 300X300CM)

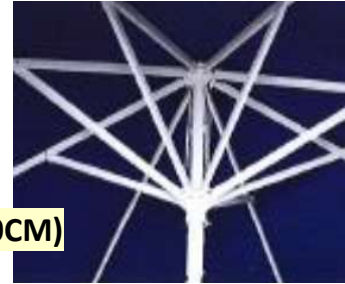

常規顏色



酒紅 墨綠 米白 卡其 寶藍 大紅 咖啡 青綠



SCD-Z006(Φ270 / 300CM)



不銹鋼柱



產品型號目錄



SCD-Z011(Φ270CM)



常規顏色



酒紅 墨綠 米白 卡其



SCD-Z012(Φ270CM)



產品型號目錄



SCD-Z013(Φ270CM)



常規顏色



酒紅 墨綠 米白 卡其



SCD-Z014(300X300 / 350X350CM)



產品型號目錄



SCD-Z015(Φ270CM / 300CM)

常規顏色



酒紅 墨綠 米白 卡其 青綠



SCD-Z016(Φ270CM / 300CM)



產品型號目錄



SCD-Z017(300X300CM)

不銹鋼支架



常規顏色



酒紅 墨綠 米白 黃色 寶藍



SCD-Z018(Φ270CM)



常規顏色



酒紅 墨綠 米白 卡其 大紅 淺咖啡 黑 灰

產品型號目錄



SCD-Z019(Φ300CM)



常規顏色



酒紅 墨綠 米白 卡其 大紅 淺咖啡 黑 灰



SCD-Z021(Φ350CM / 400CM)

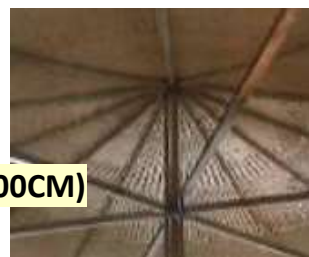

不銹鋼支架

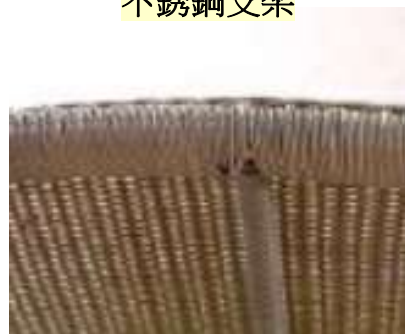

藤傘

產品型號目錄



SCD-Z020(Φ250CM)













常規顏色

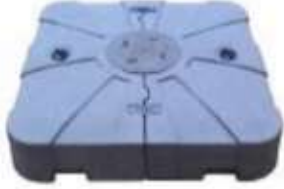

酒紅 墨綠 米白 卡其

產品型號目錄

底座系列/ Base series

 <p>扇形大理石 80kg marble base80KG</p>	 <p>三角形大理石 60kg marble base</p>	 <p>100kg水箱 100kg plastic base</p>
 <p>四合一大水箱 4 piece 90kg plastic base</p>	 <p>四合一小水箱 4 piece 60kg plastic base</p>	 <p>中柱傘水座 23kg plastic base</p>
 <p>15kg水泥底座 15kg cement base</p>	 <p>20kg水泥底座 20kg cement base</p>	 <p>20kg圓形大理石 20kg marble base</p>
 <p>8kg铸铁底座 8kg Cast iron base</p>	 <p>18kg铁板底座 18kg iron base</p>	 <p>50kg铁板底座 50kg iron base</p>

產品型號目錄



SCD-L001(300X300 / 300X400 CM)

常規顏色



酒紅 墨綠 卡其

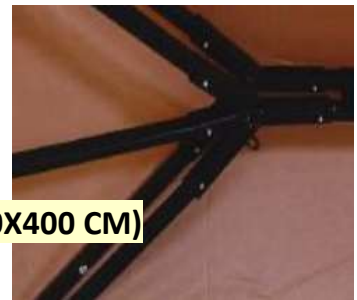

SCD-L002(300X300CM)

常規顏色



酒紅 墨綠 米白 卡其

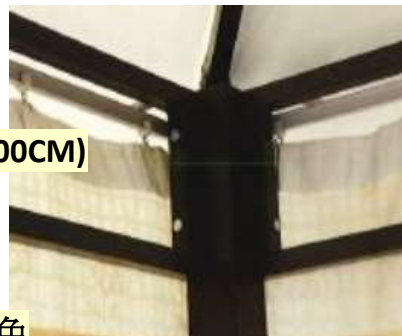

產品型號目錄



SCD-L004(300X300CM)



SCD-L005(300X600CM)

產品型號目錄

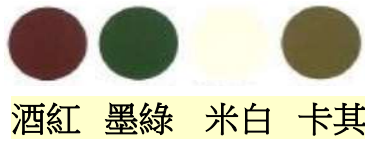

產品型號目錄



SCD-L003(250X150CM)



SCD-L008(250X150CM)



產品型號目錄



產品型號目錄



產品型號目錄



產品型號目錄

小型篷房/ Small tent

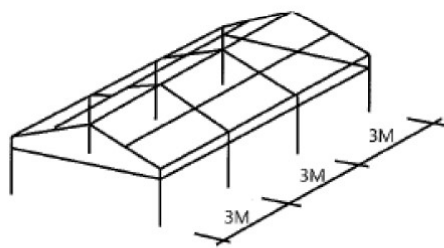
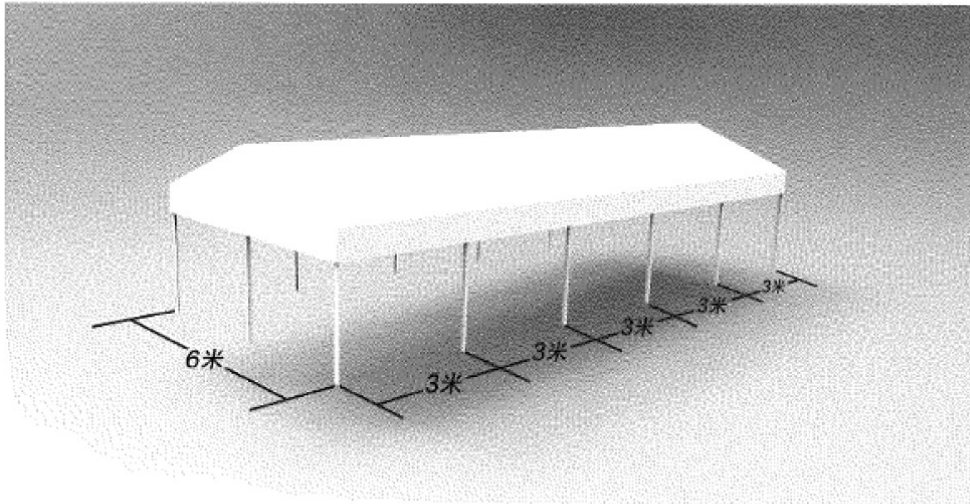

跨度 Span	间隔 Bay distance	边高 Eave Height	总高 Total Height
3M	3M	2.7M	3.2M
4M	3M	2.7M	3.4M
5M	3M	2.7M	3.6M
6M	3M	2.7M	3.8M
8M	3M	2.7M	4.2M
9M	3M	2.7M	4.4M
10M	3M	2.7M	4.6M

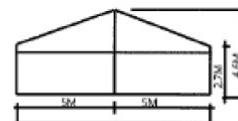
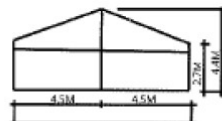
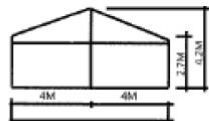
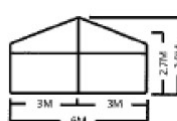
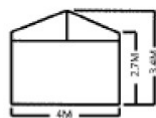
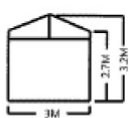

SCD-P074(600X900CM)



SCD-P075(1000X1200CM)

產品型號目錄



SCD-P066(600X3000CM)



SCD-P067(1000X1800CM)



SCD-P068(1000X2000CM)



SCD-P069(800X1500CM)



SCD-P070(1000X3000CM)



SCD-P071(1000X2000CM)



SCD-P072(800X2400CM)



SCD-P073(600X600CM)

產品型號目錄

中型篷房/ Middle-size tent

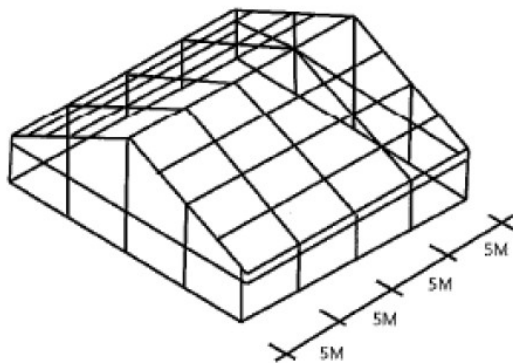
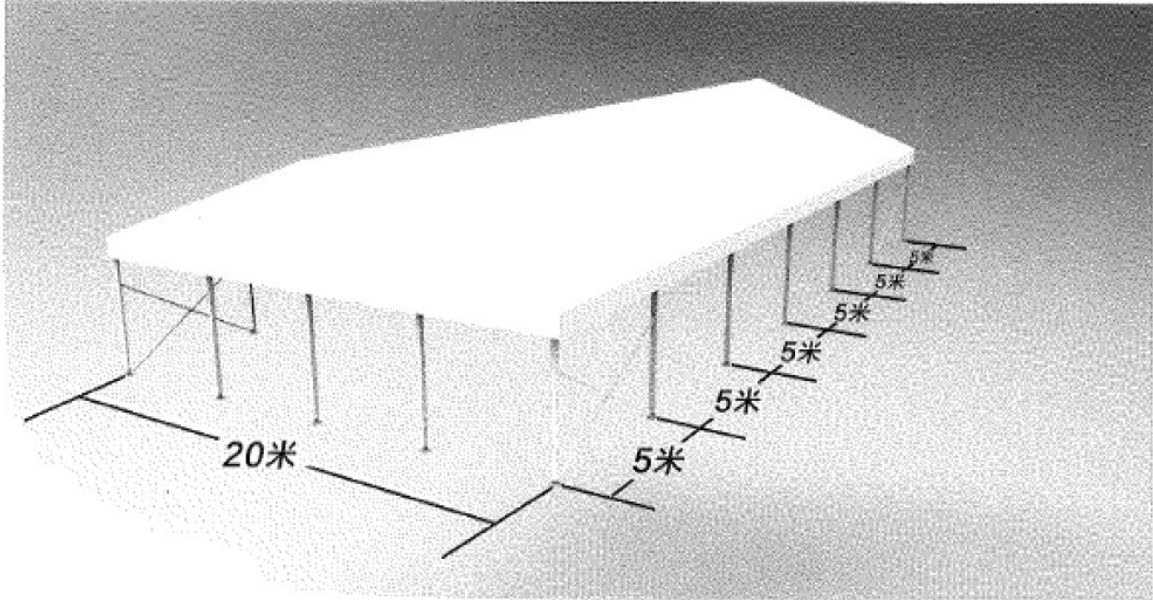

跨度 Span	間隔 Bay distance	边高 Eave Height	总高 Total Height
12M	5M	3M	4.8M
15M	5M	3M	5.7M
18M	5M	3M	6.2M
20M	5M	4M	7.2M
22M	5M	4M	7.6M

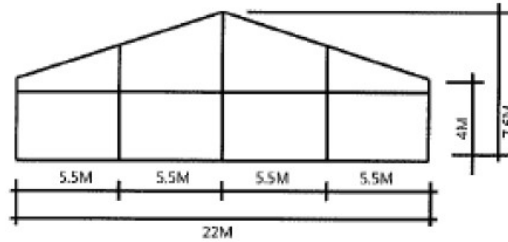
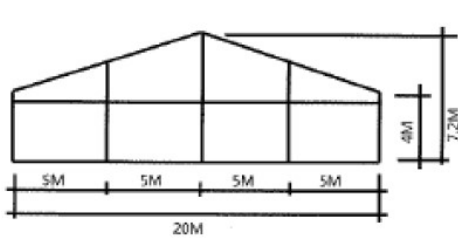
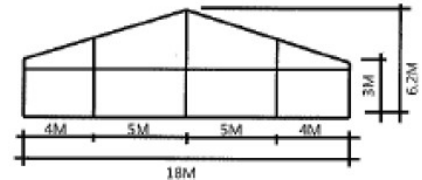
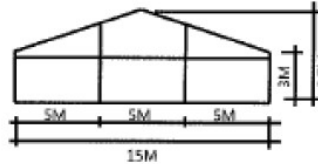
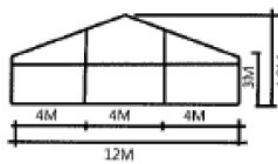

產品型號目錄



SCD-P079(2000X2000CM)



SCD-P080(2000X2000CM)



SCD-P081



SCD-P082(2000X3500CM)



SCD-P083(1500X3500CM)



SCD-P084(2000X5000CM)



SCD-P085(1500X1800CM)



SCD-P086

產品型號目錄



SCD-P087(2000X5000CM)



SCD-P088



SCD-P089(2000X2000CM)



SCD-P090



SCD-P091(2000X3000CM)

產品型號目錄

大型篷房/ Big size tent

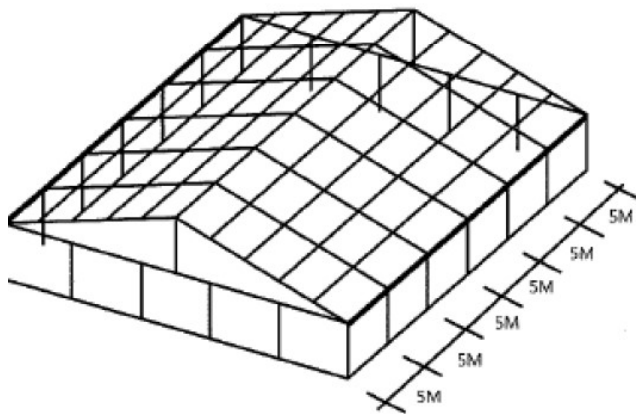
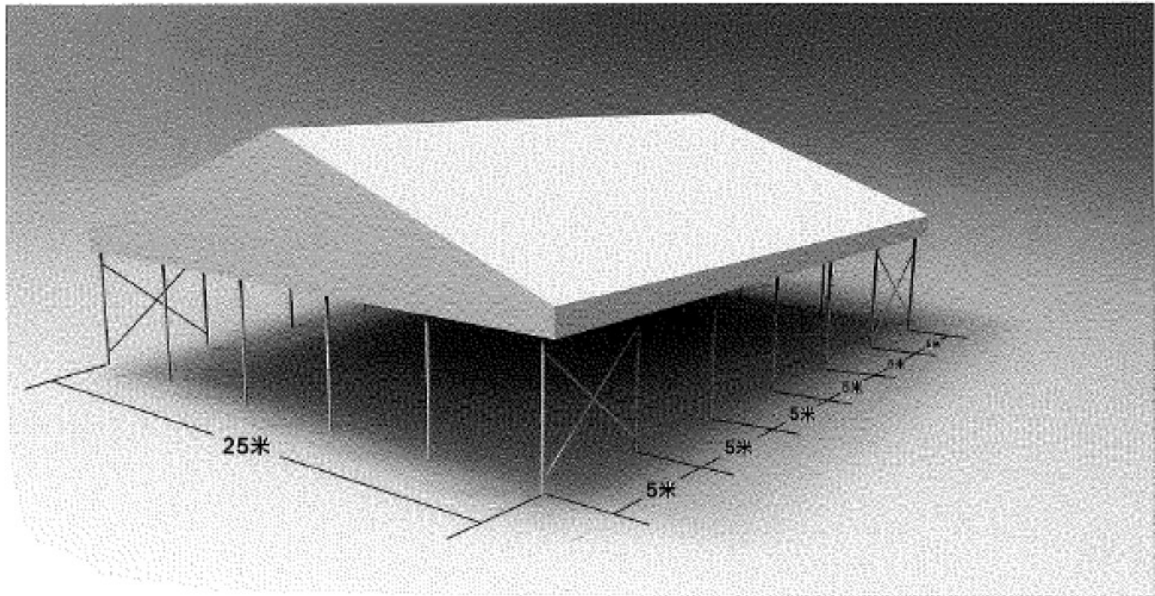

跨度 Span	间隔 Bay distance	边高 Eave Height	总高 Total Height
25M	5M	3M	4.8M
30M	5M	3M	5.7M
40M	5M	3M	6.2M

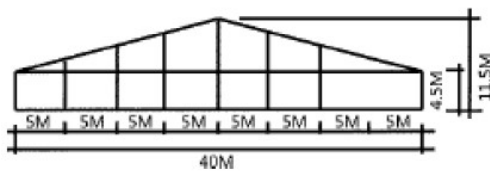
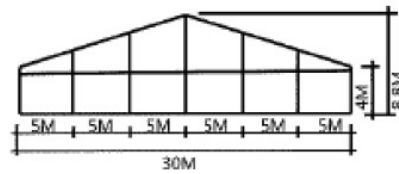
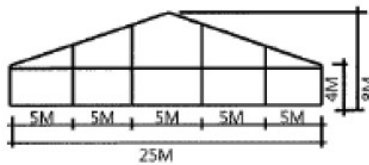

產品型號目錄

SCD-P092(3000X3000CM)



SCD-P093(3000X3500CM)



SCD-P094



SCD-P095(2500X3000CM)



SCD-P098(4500X8000CM)



SCD-P096



SCD-P097



產品型號目錄



SCD-P099(600X600CM)



SCD-P100(Φ2000CM)



SCD-P101(Φ2000CM)



SCD-P102(2000X3000CM)



SCD-P103(3000X4000CM)



SCD-P104



SCD-P105



SCD-P106



SCD-P107



SCD-P108



SCD-P109(3000X1000CM)

產品型號目錄



產品型號目錄



中柱拉膜傘(300X300 / 400X400 /
500X500 / 600X600CM)

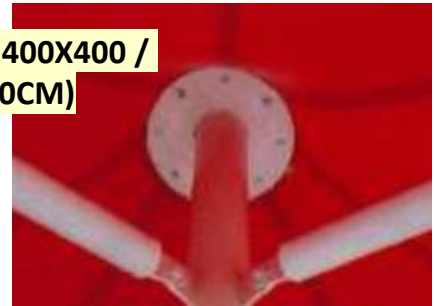

側柱拉膜傘(300X300 / 400X400 /
500X500 / 600X600CM)



產品型號目錄



SCD-M001(5000X900CM)



SCD-M002(800X2400CM)



SCD-M003(600X4200CM)

產品型號目錄



SCD-M004(600X1200CM)



SCD-M005(3000X2000CM)

產品型號目錄



SCD-P001(300X300 / 400X400 / 500X500 / 600X600CM)



SCD-P002(300X300 / 400X400 / 500X500 / 600X600CM)



SCD-P003(300X300 / 400X400 / 500X500 / 600X600CM)



SCD-P004(300X300 / 400X400 / 500X500 / 600X600CM)



SCD-P005(300X300 / 400X400 / 500X500 / 600X600CM)

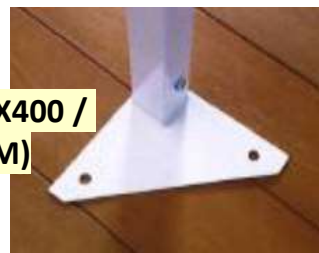

產品型號目錄



SCD-P007(300X300 / 400X400CM)



SCD-P008(300X300 / 400X400CM)



SCD-P041(300X300CM)



SCD-P042(600X600CM)



SCD-P043(600X600CM)



SCD-P044(600X600CM)



SCD-P045(500X500CM)

產品型號目錄



SCD-P046(500X500CM)



SCD-P048(1000X1000CM)



SCD-P047(400X400CM)

鋁合金棚架/ Aluminium pagoda tent : SCD-P047 (400x400cm)



SCD-P049(1000X1000CM)



SCD-P050(500X500CM)



SCD-P051(400X400CM)



SCD-P052(600X600CM)

產品型號目錄



SCD-P053(400X400CM)



SCD-P054(300X300CM)



SCD-P055(500X500CM)



SCD-P056(500X500CM)



SCD-P057(600X600CM)



SCD-P058(500X500CM)



SCD-P059(600X600CM)



SCD-P060(400X400CM)

產品型號目錄



SCD-P061



SCD-P062

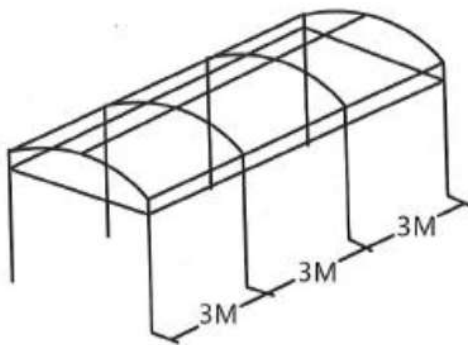

跨度 Span	间隔 Bay distance	边高 Eave Height	总高 Total Height
3M	3M	2.7M	3.2M
4M	3M	2.7M	3.3M
5M	3M	2.7M	3.4M
6M	3M	2.7M	3.5M

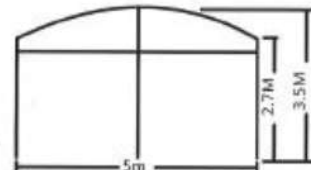
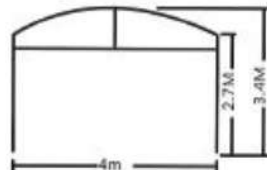
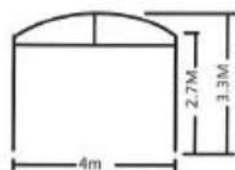
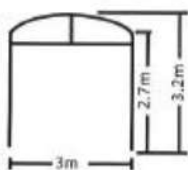

SCD-P063

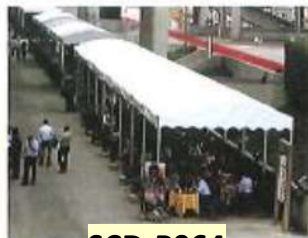

SCD-P064



SCD-P065

產品型號目錄



SCD-A01



SCD-A01S



產品型號目錄



產品型號目錄



SCD-A04C



SCD-A05



SCD-A04



SCD-A05S



產品型號目錄



SCD-B01



SCD-B03



SCD-B02

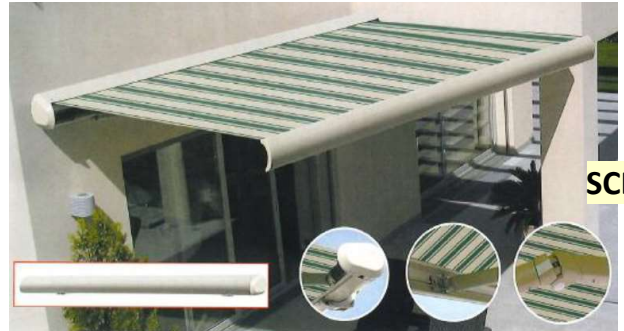

SCD-B04



SCD-B05

產品型號目錄

法式篷 (French style awning)



SCD-SKA067

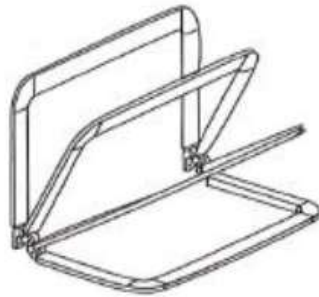

SCD-SKA070



SCD-SKA068



SCD-SKA071



SCD-SKA069

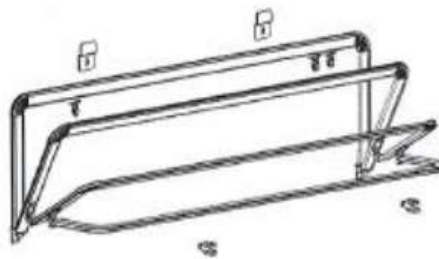

SCD-SKA072

產品型號目錄

彈弓臂帳篷



SCD-SKA04

露台帳篷



SCD-SKA01

天地柱撐杆帳篷



產品型號目錄

天幕篷

SCD-TM01



SCD-TM02



產品型號目錄

SCD-TM03



常规尺寸:
 (1) 2X2m 3X2m 4X2m 5X2m 6X2m
 (2) 2X3m 3X3m 4X3m 5X3m 6X3m
 (3) 2X4m 3X4m 4X4m 5X4m 6X4m
 (4) 2X5m 3X5m 4X5m 5X5m 6X5m
 (5) 2X6m 3X6m 4X6m 5X6m 6X6m
 另外, 还有其它特殊尺寸, 欢迎来电咨询。

SCD-TM04



常规尺寸:
 (1) 2X2m 3X2m 4X2m 5X2m 6X2m
 (2) 2X3m 3X3m 4X3m 5X3m 6X3m
 (3) 2X4m 3X4m 4X4m 5X4m 6X4m
 (4) 2X5m 3X5m 4X5m 5X5m 6X5m
 (5) 2X6m 3X6m 4X6m 5X6m 6X6m
 另外, 还有其它特殊尺寸, 欢迎来电咨询。

SCD-TM05

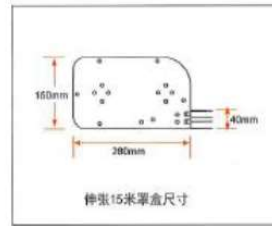

产品特性: Product features

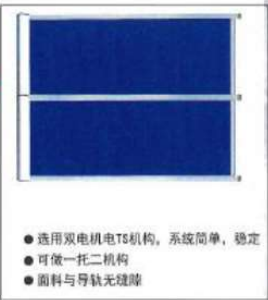
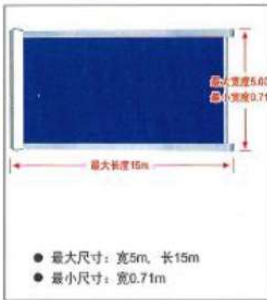
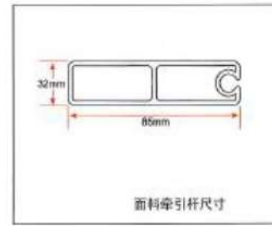
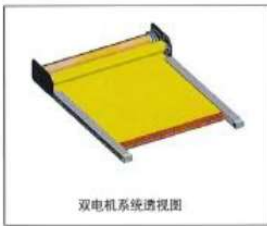

- 最大尺寸: 宽5m, 长15m
- 最小尺寸: 宽0.71m
- 选用双电机电TS机构, 系统简单, 稳定
- 可做一托二机构
- 面料与导轨无缝隙
- 运行正反均为双电机驱动, 无任何其他辅助机构 (如弹簧、液压等), 系统稳定
- 双电机运行到任何位置停止均为面料张紧状态。

帐篷布料

遮阳篷面料 (Awning Fabric)

一、001系列PVC彩条布: 0.35±0.01mm(厚度)X1.82m(幅度)X38Y(长度)

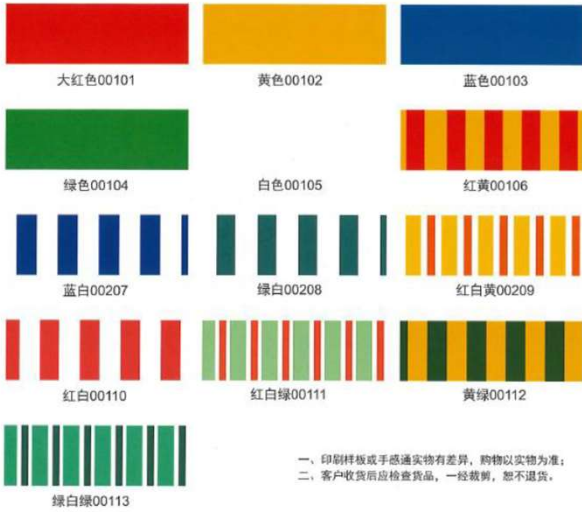

一、印刷样板或手感实物有差异, 购物以实物为准;
二、客户收货后应检查货品, 一经裁剪, 恕不退货。

二、002系列PVC加筋涂层布: 50m(长度)X2.0m(宽度)X0.38mm(厚度)420g



一、印刷样板或手感实物有差异, 购物以实物为准;
二、客户收货后应检查货品, 一经裁剪, 恕不退货。

遮阳篷面料 (Awning Fabric)

五、005系列国产澳丝布料: 280g/m² 以实际颜色为准, 仅供参考

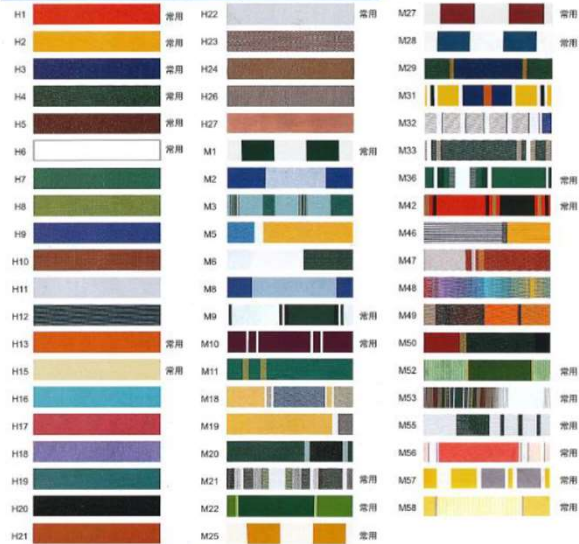

六、006系列国产高防水、高日晒布料: 400g/m²

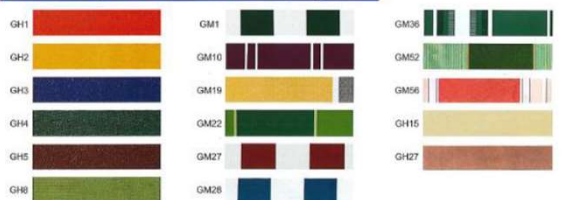

遮阳篷面料 (Awning Fabric)

三、003系列PVC涂层布 30m(长度)X2.0m(宽度)X0.40mm(厚度)500g



四、004系列PVC涂层布: 60m(长度)X2.1m(宽度)X0.45mm(厚度)550g



一、印刷样板或手感实物有差异, 购物以实物为准;
二、客户收货后应检查货品, 一经裁剪, 恕不退货。

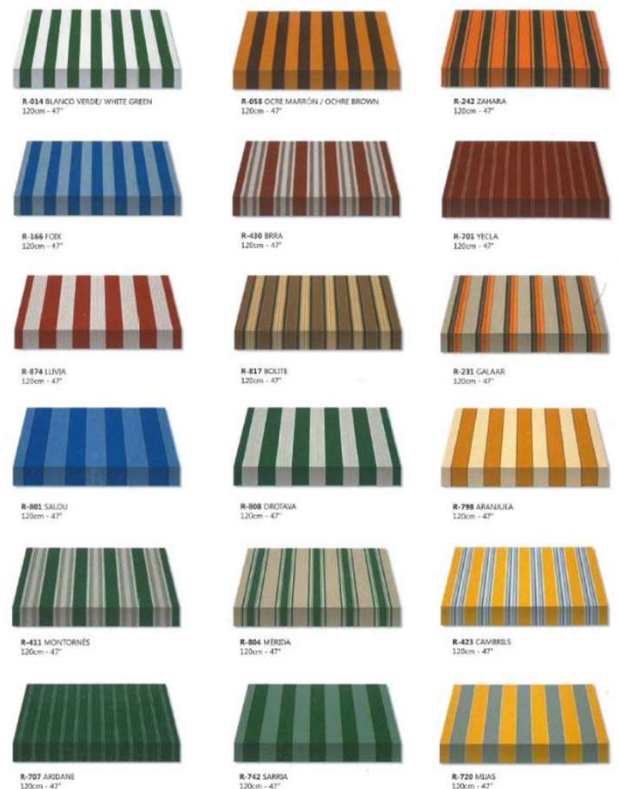

帳篷布料

1.2X60m (色牢度：5年不褪色)

TECHNICAL FEATURES 技术参数	
Composition 成分	100% Solution Dyed Acrylic- 100% 溶染亚克力
Width 布宽	120cm-47"(Standard)—标准尺寸 220/250cm-86"/98"(As per design)—定制尺寸
Weight 重量	290g m ² ± 5%
Finish 加工形式	Special finish for awnings. Antistain, rot - proof and water resistant. —特别处理, 防褪色、防腐蚀、防水。
Water Column 水压	>300mm (ISO 811/81)
Oil Repellency 防油性	≥ 5
Water Repellency 防水性	≥ 5
Tensile Strength Warp 经向拉力	125 daN / 5cm ± 5%
Tensile Strength Weft 纬向拉力	70 daN / 5cm ± 5%
Tear Strength Weft 经向撕力	3 daN / ± 10%
Tear Strength Warp 纬向撕力	2 daN / ± 10%
Standard Roll Length 标准卷长	60m / 65,64 yds

进口面料系列是全天候户外遮阳织物，有高品质的溶染亚克力纤维 (100% solution dyed acrylic fiber) 织造而成，由于在拉丝成型阶段，色素分子即以液体为媒介溶入到纤维的核心，达到最佳的着色效果，从而保证了高在达五年的色牢度和十年以上的使用寿命；再经过过硬的化学处理和表面涂层，使得织物更加挺实、美观，大大加强了织布的抗紫外线、抗水和抗污染性能，同时还具有极高的耐候性，以满足各种和气候条件下的需求，其技术指标均达到了ISO质量标准。